

REV.	ECN NO.	LOCAS.	DESCRIPTION	DATE	DESIGN
A0				081018	HANG

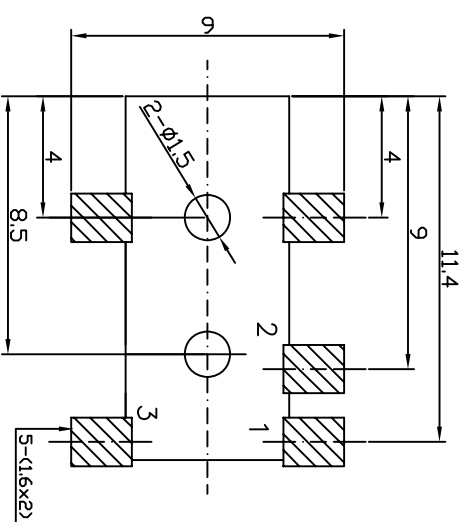

PCB LAYOUT

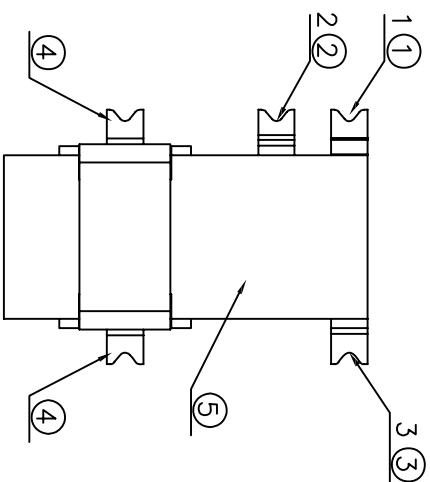
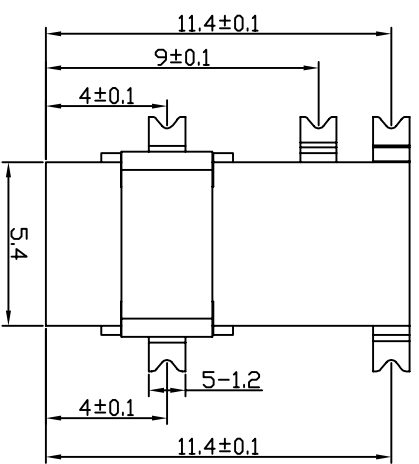
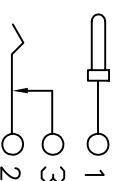
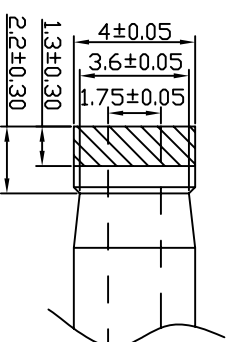
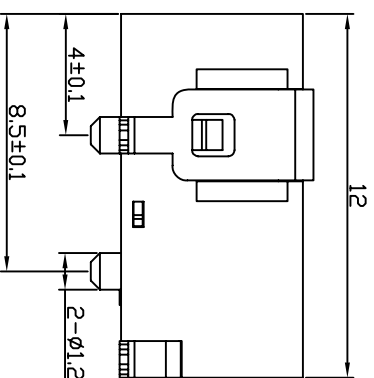
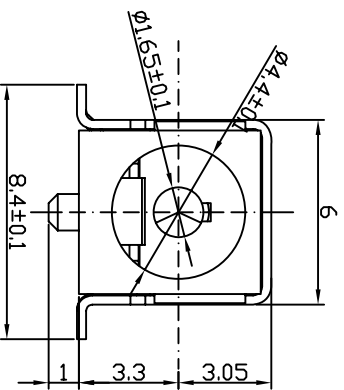

CIRCUIT DIAGRAM

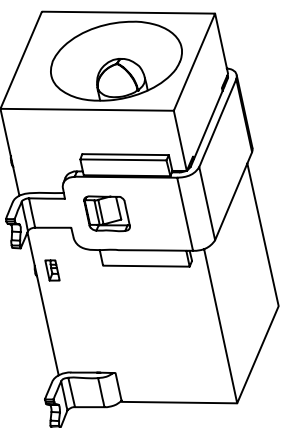

No.	PART NAME	QTY	MATERIAL (THICK, COLOR)	REMARK
⑤	HOUSING	1	PA-9T2330 (BLACK)	
④	TERMINAL	1	BRASS t=0.30	Ag-Plated
③	TERMINAL	1	BRASS t=0.30	Ag-Plated
②	TERMINAL	1	PHOSPHOR BRONZE t=0.30	Ag-Plated
①	TERMINAL	1	BRASS t=0.30	Ag-Plated

<b>LASTAR</b>		Lastar Technology CO., LTD	
DRAW NO.	DC-09098-16	DATE	081218
DESIGN	HANG		
CHECK	WANGCM		
APPROVED	HUYX		
DRAW NAME: DC POWER JACK		P/N NO.	DC-09098-16
UNIT:	mm	SHEET:	N/A
FILE:		MODEL:	
REV. B		SCALE	N/A